



HAL
open science

Inhibition of Hepatitis C Virus Infection in Cell Culture by Small Interfering RNAs.

Christophe Chevalier, Aure Saulnier, Yann Benureau, Dorian Fléchet, David Delgrange, Florence Colbère-Garapin, Czeslaw Wychowski, Annette Martin

► **To cite this version:**

Christophe Chevalier, Aure Saulnier, Yann Benureau, Dorian Fléchet, David Delgrange, et al.. Inhibition of Hepatitis C Virus Infection in Cell Culture by Small Interfering RNAs.. *Molecular Therapy*, 2007, 15 (8), pp.1452-62. 10.1038/sj.mt.6300186 . pasteur-00166450

HAL Id: pasteur-00166450

<https://pasteur.hal.science/pasteur-00166450>

Submitted on 24 Aug 2007

HAL is a multi-disciplinary open access archive for the deposit and dissemination of scientific research documents, whether they are published or not. The documents may come from teaching and research institutions in France or abroad, or from public or private research centers.

L'archive ouverte pluridisciplinaire **HAL**, est destinée au dépôt et à la diffusion de documents scientifiques de niveau recherche, publiés ou non, émanant des établissements d'enseignement et de recherche français ou étrangers, des laboratoires publics ou privés.



Distributed under a Creative Commons Attribution - NonCommercial - NoDerivatives 4.0 International License

Inhibition of hepatitis C virus infection in cell culture by small interfering RNAs

Christophe Chevalier^{1*}, Aure Saulnier^{1,2*}, Yann Benureau¹, Dorian Fléchet¹, David Delgrange³, Florence Colbère-Garapin², Czeslaw Wychowski³, and Annette Martin^{1#}

¹CNRS URA 1966, Unité de Génétique Moléculaire des Virus Respiratoires & ²Laboratoire des Virus Entérotropes et Stratégies Antivirales, Institut Pasteur, Paris, France; ³CNRS-UMR 8161, Institut de Biologie de Lille, Institut Pasteur de Lille, Lille, France

* These authors contributed equally to the work

Correspondence should be addressed to Annette Martin, URA CNRS 1966, Unité de Génétique Moléculaire des Virus Respiratoires, Institut Pasteur, 25 rue du Dr. Roux, 75724 Paris Cedex 15, France, Tel: +33 1 40613360, Fax: +33 1 40613045, annettem@pasteur.fr

Short title: Silencing of hepatitis C virus infection

ABSTRACT

Hepatitis C virus (HCV) infection is a major cause of chronic liver disease and hepatocellular carcinoma, yet fully efficacious treatments are missing. In the present work, we investigated RNA interference, a specific gene silencing process mediated by small interfering RNA (siRNA) duplexes, as an antiviral strategy for HCV. Synthetic siRNAs were designed to target conserved sequences of the HCV 5' nontranslated region located in a functional, stem-loop structured domain of the HCV internal ribosome entry site (IRES), which is crucial for polyprotein translation initiation. Several siRNAs dramatically reduced or even abrogated the replication of selectable subgenomic HCV replicons upon cotransfection of human hepatoma cells with viral target and siRNAs, or transfection of cells supporting autonomous replication of HCV replicon with siRNAs. Importantly, three siRNAs also proved capable of strongly inhibiting virus production in cell culture. One siRNA, targeting a sequence highly conserved across all genotypes that forms a critical pseudoknot structure involved in translation, was identified as the most promising therapeutic candidate. These results indicate that HCV life cycle can be efficiently blocked using properly-designed siRNAs that target functionally-important, highly conserved sequences of the HCV IRES, offering a novel approach to develop IRES-based antiviral treatment of chronic HCV infections.

INTRODUCTION

Persistent hepatitis C virus (HCV) infection is established in the liver with high frequency, leading to the development of chronic hepatitis, and possibly liver cirrhosis and hepatocellular carcinoma at later stages. Chronic HCV infection concerns 2.2% of the World's population and is known to be the leading cause of liver transplantation in developed countries. No vaccine is available for HCV and the current treatment, consisting in the administration of pegylated interferon α and ribavirine proved to have limited efficacy on certain HCV genotypes, as well as general adverse effects [reviewed in Ref. 1]. The development of alternative, specific therapies for chronic HCV infection is thus a major public health objective.

HCV, as a member of the *Flaviviridae* family, contains a single-stranded positive RNA genome that encodes a unique precursor polyprotein which is further processed into structural proteins and nonstructural proteins ensuring genome replication. The long open reading frame is flanked by 5' and 3' nontranslated regions (NTR) that are highly conserved among the majority of HCV genotypes and contain elements that are essential for genome replication [reviewed in Ref. 1]. In addition, HCV 5'NTR contains a highly structured element, an internal ribosomal entry site (IRES), that is essential for the initiation of HCV polyprotein translation [2]. Anti-HCV drug development has been hampered by the lack of both efficient cell culture systems that support virus replication and accessible animal models. Until recently, HCV subgenomic RNA replicon systems [3] only allowed to assay the inhibitory effect of antiviral candidates on HCV genome replication *in vitro*, in human hepatoma cells. The recent development of stable cell culture systems permitting robust production of

infectious HCV particles *in vitro*, based on the JFH-1 strain of HCV genotype 2a [4], will facilitate the investigation and testing of new antiviral strategies. In addition, alternative animal models which have been recently developed are promising for the evaluation of candidate antiviral therapeutics. These include transgenic mice engrafted with human hepatocytes [5], as well as nonendangered primate species (tamarins, marmosets) infected by GB virus B (GBV-B), a hepatotropic virus that is closely related to HCV [6, 7], or by GBV-B derivatives containing functional HCV sequences [8].

Among possible therapeutic strategies, RNA interference (RNAi) is an attractive path to explore. First described as a natural defense mechanism against plant viruses, RNAi was subsequently shown to be a universal phenomenon of post-transcriptional gene silencing that is initiated by double-stranded RNA and leads to specific degradation of homologous RNAs. This process involves the generation of 21-nucleotide short interfering RNAs (siRNAs) which, in association with a multiprotein complex named RNA induced silencing complex (RISC), are used as guides to target specific RNA substrates by Watson-Crick base pairing. Such siRNAs, when introduced directly into mammalian cells or expressed from viral vectors, can lead to the degradation of targeted sequences [reviewed in Ref. 9]. During the past few years, RNAi has been extensively investigated as an alternative specific therapy to treat cancers, genetic diseases, as well as infections by various human pathogens of medical importance, using both *in vitro* and *in vivo* model systems [reviewed in Refs. 10, 11]. RNA viruses, in particular viruses with liver tropism such as HCV, are ideal candidates for nucleic acid-based therapies which have been shown to predominantly target the liver [reviewed in Ref. 12]. Recently, various studies have reported on the variable inhibitory effect of HCV-specific synthetic siRNAs or small hairpin RNAs (shRNAs) expressed from viral vectors that

target sequences encoding various HCV nonstructural proteins, as well as sequences within the 5'NTR [13-19]. These studies all relied on the use of HCV subgenomic or genomic replicon models in cell culture.

In the present work, we designed siRNAs targeting highly conserved sequences within the HCV 5'NTR. The efficiency of these HCV-specific siRNAs was first evaluated using previously described self-replicating HCV RNAs [20, 21]. This allowed us to select four siRNAs that abrogated or substantially reduced genome replication. Using these siRNAs in recently described cell culture systems supporting the production of genotype 2a JFH-1 [4] or chimeric 1a/2a (Delgrange et al., unpublished data) infectious particles, we demonstrated the successful silencing of HCV infection in cell culture.

RESULTS

Selection of siRNAs targeting HCV 5'NTR

To investigate the potency of virus-specific siRNAs to inhibit HCV infection, we selected 7 siRNAs that target conserved sequences of the pivotal domain (domain III) of the HCV IRES within the 5'NTR [2] (Fig. 1a). This domain is particularly important for initiation of polyprotein translation, as it directly contacts 40S ribosomal subunits [22] and binds translation initiation factor 3, eIF3 [23]. Domain III has also been reported to be involved to some extent in genome replication [24]. siRNAs were designed essentially using previously described criteria, and in particular, whenever possible, asymmetric thermostability of siRNA duplexes was respected [25, 26]. As a messenger, HCV positive strand RNA genome is an

ideal target for siRNAs, but it harbors strong secondary and tertiary structures, in particular within the IRES, which makes the design of optimal siRNAs difficult according to the criteria referenced above. In contrast, the high nucleotide conservation of this region permitted to identify siRNAs that were homologous to several HCV genotypes (Table 1). Selected siRNAs were named according to the nucleotide position within the genome of the H77 strain of HCV genotype 1a [27] that corresponds to the first 5' nucleotide targeted by the siRNA antisense strand : si205, si214, si240-1a, si240-1b, si244, si284, si313 (Table 1). siRNA si313 targets the 3' end of domain III and 5' end of domain IV involved in a pseudo-knot located upstream from the initiator codon (Fig. 1a). The sequence of all siRNAs, with the exception of si240, matched both HCV genotype 1a and 1b sequences present in the subgenomic replicons used in the first part of the study (Fig. 1b). Two siRNAs si240 (si240-1a and si240-1b) were thus synthesized with sequence homologous to either genotype 1a or 1b, respectively. When targeted to genotype 1b 5'NTR, si240-1a formed a G:U wobble base-pairing at position 18 of the siRNA antisense strand, whereas si240-1b formed an A:C mismatch with the genotype 1a replicon (Fig. 1c). The G:U non-canonical base-pairing is known to be non-disruptive in double-stranded RNA structures and both G:U wobble base-pairing and A:C mismatch, if present at certain positions of the siRNA, were recently reported to be well tolerated for siRNA-mediated gene silencing [28-31]. Therefore, we undertook to analyze the effect of si240-1a and si240-1b on both homologous and heterologous replicon targets. Finally, an irrelevant siRNA, referred to as siIRR (Table 1), previously used to target a sequence within the 5'NTR of a poliovirus strain [30], that did not share homology with HCV sequence, was used as a non-specific, negative control in these experiments.

Effect of siRNAs on the replication of reporter HCV subgenomic replicon

First, we evaluated whether selected siRNAs were able to inhibit the replication of an HCV subgenomic replicon (Ntat2ANeo) in cell culture, using a previously described system that allowed simple monitoring of RNA replication by measurement of an enzymatic activity, secreted alkaline phosphatase (SEAP) activity [21] (see Material and Methods and Fig. 1b). All HCV sequences of Ntat2ANeo replicon are derived from the N strain of genotype 1b, with the exception of the 5'NTR, which is derived from the H77 strain of genotype 1a.

Following coelectroporation of En5-3 cells with 5 µg of *in vitro*-transcribed Ntat2ANeo RNA and 2 µg of each synthetic siRNA, culture supernatant was replaced daily with fresh medium during the first 4 days after transfection, then at 7 days post-transfection, and SEAP activity was measured in all culture supernatants collected. During the first 2 days, SEAP signals essentially reflected translation of the input RNAs, since SEAP levels were roughly similar in cells transfected with Ntat2ANeo replicon or with a replication-defective RNA encoding an inactive NS5B RNA polymerase deleted in its active site (Δ GDD, see Material and Methods). RNA replication was then clearly detected between 3 and 7 days post-transfection (Fig. 2a, compare SEAP levels in cells transfected with Ntat2ANeo and Δ GDD). Co-transfection of the irrelevant siRNA, siIRR, did not significantly affect Ntat2ANeo replication (Fig. 2a). HCV-specific siRNAs si214 and si284 showed only transient or no effect on HCV replication, respectively, and SEAP expression levels at 7 days post-transfection were similar to that induced by transfection of Ntat2ANeo alone (Fig. 2a). These two siRNAs were thus not further utilized in the course of our study. In sharp contrast, siRNAs si205, si240-1a, si240-1b, si244 and si313 proved capable of abolishing HCV replication in this system, yielding SEAP levels as low as those obtained with replication-defective RNA Δ GDD. In the presence

of these siRNAs, SEAP levels were even slightly lower at days 1, 2 and 3 post-transfection than those obtained with Δ GDD, as a result of siRNA-mediated degradation of input RNAs, that were thus not available for translation (Fig. 2a). The inhibitory effect of these 5 siRNAs on HCV replication was shown to be prolonged over 14 days post-transfection, when examined (data not shown).

We next monitored dose-response effects of each of the 5 selected siRNAs using decreasing siRNA doses in the range of 2000 to 4 ng (67 - 0.13 nM per μ g replicon) in coelectroporation experiments with 5 μ g of Ntat2ANeo replicon (Fig. 2b). From these experiments, inhibition doses 50 (ID_{50}) were calculated for each siRNA (Fig. 2b). siRNAs si240-1a and si244 proved to be the most efficient inhibitors of HCV RNA replication with ID_{50} s of 19 ng (0.64 nM) and 33 ng (1.11 nM), respectively, while all siRNAs exhibited ID_{50} s within the 19-141 ng range. The ID_{50} of si240-1b (127 ng) was shown to be substantially higher than that of si240-1a (19 ng), in agreement with the fact that si240-1b is not fully homologous to Ntat2ANeo 5'NTR (genotype 1a), thereby demonstrating the sequence-specificity of these siRNAs. We also found that the co-administration of two siRNAs targeting nonoverlapping HCV sequences, used at suboptimal doses, resulted in additive inhibitory effects (data not shown). This might prove useful in future studies in which a strategy based on combined siRNAs is sought to prevent the occurrence of escape mutations. The five siRNAs (si205, si240-1a, si240-1b, si244, si313) that specifically target domain III of the HCV IRES and strongly inhibit subgenomic RNA replicon replication when used in the nM range were retained in the remaining of the study.

Viral RNA detection in siRNA-treated cells

We next investigated whether HCV replicon RNA was eliminated in siRNA-treated cells in which SEAP activities were at basal level, to determine whether siRNAs were capable of curing replicon-containing cells. Total RNA was extracted from cells cotransfected with replicon and siRNA at 10 days post-transfection and analyzed for HCV RNA by semi-quantitative RT-PCR using an HCV primer pair allowing amplification of a 1630-bp fragment that spans the NS3 coding region, as well as a primer pair allowing the detection of a housekeeping mRNA (GAPDH) for RNA quantity normalization purposes (Fig. 2c). HCV RNA was readily detected in cells transfected with Ntat2ANeo or cotransfected with Ntat2ANeo and siIRR at similar abundances (Fig. 2c, lanes 4, 5). Very low levels of residual transfected Δ GDD RNA molecules could be occasionally detected in these experimental conditions (Fig. 2c, lane 3). Viral RNA was not detected or weakly detected, at a level comparable to that of Δ GDD RNA, in cells cotransfected with Ntat2ANeo and si240-1a, si244 or si313 in duplicate experiments (Fig. 2c, lanes 8-13). HCV RNA was consistently detected in cells cotransfected with Ntat2ANeo and si205 (Fig. 2c, lanes 6, 7), but at lower levels than in cells cotransfected with Ntat2ANeo and siIRR. These results correlated well with inhibition levels of reporter SEAP activities and confirmed that HCV RNA replication was strongly inhibited, if not abolished, in cells treated with 2 μ g of the three most efficient siRNAs (si240-1a, si244, si313).

Effect of siRNAs in a replicon-containing cell line

In order to work with a cell culture system mimicking an established persistent infection, we analyzed the inhibitory capacity of siRNAs in En5-3 cells that stably contain and

continuously replicate Ntat2ANeo replicon. The ongoing replication of Ntat2ANeo replicon in these cells was reflected by >10-fold higher SEAP levels than in transient experiments after HCV replicon electroporation. Two μg of each siRNA were electroporated into these cells and their effect on HCV RNA replication was determined at different time-points. Data obtained at 7 days post-transfection, corresponding to cumulative SEAP levels secreted between days 4 and 7 post-transfection, are represented in figure 3. SEAP activity generated by HCV replicon in the presence of either homologous siRNA was reduced by 50% or more relative to that of Ntat2ANeo in mock-transfected cells. When a higher dose (5 μg) of siRNAs was used, SEAP activity was reduced by 70-93% (data not shown). siRNA-mediated inhibitory effect was not as dramatic as in cotransfection experiments, likely due in part to limited transfection efficiency ($\sim 70\%$, data not shown), permitting ongoing RNA replication in cells that did not receive siRNA in the transfected culture. In addition, viral RNAs undergoing replication within replication complexes may be less accessible to transfected siRNAs than cotransfected viral RNAs. Nonetheless, we demonstrated strong, dose-dependent inhibitory potency of HCV domain III-specific siRNAs in cells supporting continuous HCV RNA replication.

Effect of siRNAs on G418-resistant cell clone formation

We next addressed the question of the efficacy of siRNAs on HCV genome replication in cells placed under selective pressure and determined whether HCV escape to specific siRNA treatment occurred. In these experiments, we used the HCV replicon-free subclone 2-3c of Huh7 cells [32] and either Ntat2ANeo or NNeo replicon. In contrast to Ntat2ANeo, NNeo replicon (see Fig. 1b; [20]) contains a 5'NTR derived from the N strain of genotype 1b and

only encodes neomycine phosphotransferase gene in the first cistron. 2-3c cells were coelectroporated with either Ntat2ANeo or NNeo replicon and each siRNA, placed under G418 selective pressure, and G418-resistant cell clones were numbered at 21 days post-transfection. Figure 4 shows means of 2-3 experiments carried out with each replicon, which were pooled for siRNAs homologous to both replicons (si205, si244, si313). A mean of 34,000 resistant cell clones \pm 23800 was obtained after transfection of HCV replicon alone. Data are represented with respect to 10,000 G418-resistant clones in each experiment. Treatment with all HCV-specific siRNAs resulted in substantial reduction of the number of G418-resistant cell clones (Fig. 4). siRNA si205 reduced by \sim 2 logs the formation of G418-resistant cell clones, whereas si244 and si313 reduced cell clone formation by 3 logs or more (Fig. 4a), which is in good correlation with results obtained in the SEAP reporter system. Both si240-1a and si240-1b were more efficient on their homologous target than on heterologous targets (Fig. 4b). The nature and the position of the mismatch between si240 and its target (G:U and A:C for si240-1a on HCV genotype 1b and si240-1b on genotype 1a, respectively, at nucleotide 18 of the siRNA antisense strand) are reasonably well tolerated by the RNAi machinery, resulting in \sim 2 log reduction in G418-resistant cell clone formation, an inhibition that was, however, 1-1.5 log less efficient than on homologous targets. These experiments confirmed, as already described [28, 29, 31], that perfect base pairing between siRNAs and targeted mRNA is required for most effective silencing.

To look for potential emergence of siRNA escape mutants, several G418-resistant cell clones obtained after a single treatment with each siRNA were isolated and independently amplified. The 5'NTRs of the HCV replicon RNAs recovered from 3-13 cell clones for each siRNA were reverse-transcribed and PCR amplified. Resulting PCR products were subjected to

sequencing. No nucleotide substitution was found within or in the vicinity of the siRNA-targeted region of the HCV replicon RNAs. These data suggest that either a single siRNA treatment may not be sufficient to select for HCV replicon escape mutants in this system, or that replication competence does not tolerate nucleotide variation in this genomic region.

Inhibitory effect of siRNAs on virus replication in cell culture

We sought to determine whether siRNAs si240-1a, si244, and si313, that were shown to be most efficient in inhibiting the replication of HCV subgenomic replicons both transiently and under selective pressure, were also capable of efficiently blocking virus infection in cell culture. We utilized the JFH-1 strain of HCV genotype 2a that was shown to infect Huh7 and Huh7-derived cell lines and produce infectious particles [4]. This *in vitro* infectious system hence recapitulates the entire HCV life cycle. Sequences of si240-1a and si313 were perfectly homologous to the 5'NTR sequence of this genotype 2a strain. In contrast, si244 hybridized to the JFH-1 5'NTR with a C:A mismatch at the third position of the siRNA antisense strand (see Fig. 1c). Such a mismatch at the 5' end of the antisense strand is expected to hamper RNA interference [29, 33]. For this reason, we also used an engineered chimeric virus that contains 5'NTR and core-coding sequences derived from genotype 1a within the backbone of the JFH-1 genome (JFH-1/C(+)-1a; Delgrange et al., unpublished data). The three siRNA sequences are homologous to the 5'NTR of this chimeric virus. To monitor the inhibitory effect of siRNAs on HCV infection, HuAP cells were electroporated with each siRNA and infected with either JFH-1 or the chimeric 1a/2a virus JFH-1/C(+)-1a. Infected cells were probed by immunofluorescence with anti-core (Fig. 5a) or anti-E2 (data not shown) monoclonal antibodies. Most cells in the control cultures infected with JFH-1/C(+)-1a (Fig.

5a, left panel) or JFH-1 (Fig. 5a, right panel) were antigen-positive. Non-specific siRR had no detectable effect on HCV infection (Fig. 5a). In contrast, HCV-specific siRNA si313 reduced considerably the number of cells infected with either JFH-1 or the chimeric virus (Fig. 5a). Similarly, si244 inhibited efficiently infection with the 1a/2a chimeric virus (Fig. 5a, left), but had only a weak effect, if at all, on JFH-1 infection (Fig. 5a, right), consistent with the existing mismatch between si244 and genotype 2a 5'NTR (see Fig. 1c). Interestingly, si240-1a siRNA also appeared to have a higher inhibitory effect on the infection with the chimeric virus (Fig. 5a, left) than with JFH-1 (Fig. 5a, right), in spite of perfect homology with the 5'NTR sequence of both viruses. We hypothesized that these differential effects of si240-1a might be linked to delayed replication kinetic of the chimeric 1a/2a virus, as compared to JFH-1 (Delgrange et al., unpublished data), a phenotype that may impact on target/siRNA ratios at early times post-infection. The effect of the three siRNAs on both viruses was also monitored by western blot analysis of E2 expression in infected cells (Fig. 5b). Data confirmed that si313 was the most efficient siRNA, which resulted in complete inhibition of E2 expression in cells infected with either JFH-1 or JFH-1/C(+)-6-1a.

To verify that virus production from siRNA-treated cells was accordingly reduced, viral particles were titrated in supernatants from cells transfected with each siRNA and infected with either JFH-1 or the chimeric virus, both by real-time quantitative RT-PCR (genome equivalents, g.e., Fig. 5c) and by determination of infectious focus forming units (FFU) (Table 2). For all siRNAs, quantification of virus production in siRNA-treated cultures (Fig. 5c, Table 2) was in good agreement with core and E2 intracellular expression levels (Fig. 5a-b). In particular, supernatants from si313-treated, HCV-infected cells exhibited a >92% reduction in ge/mL titer and a >96% reduction in FFU/mL infectious titer, compared to mock-

treated, HCV-infected cells. Altogether, these data demonstrate that HCV 5'NTR-specific siRNAs are capable of strongly inhibiting virus production in cell culture.

DISCUSSION

To explore RNAi as a potential new therapeutical approach against HCV infection, one of the reasons why we chose to target domain III of the HCV 5'NTR resides in that domain III contains well conserved nucleotide sequences across all HCV genotypes (Table 1) [34]. The high conservation degree of these sequences may be required to preserve virus functions, since this 5'NTR domain controls the initiation of polyprotein translation and modulate RNA replication [23, 24]. Recent NMR and electron cryomicroscopy studies of domain III [22, 35, 36] helped identify the structure/function relationship of the various III subdomains. These studies suggested that subdomains IIIa/c and IIIId, as well as subdomain IIIIf that forms a pseudoknot structure (Fig. 1a) directly contact the 40S subunit body and act synergistically for the proper positioning of the AUG codon. In the present work, si240 and si244, that hybridize to subdomain IIIId, and si313, that essentially hybridizes to the IIIIf pseudoknot, thus target regions that are essential for IRES structural integrity and function. These three siRNAs proved able, at low doses in the nM range, to substantially reduce or even abolish HCV subgenomic RNA replication, as measured by reporter SEAP activities and G418-resistant cell clone formation (Figs. 2, 4), and resulted in the elimination of HCV replicons from treated cells (Fig. 2c). Importantly, we also demonstrated that these siRNAs, particularly si313, considerably limited HCV infection in cell culture, using two HCV strains that can be

propagated in Huh7-derived cells, the JFH-1 strain of HCV genotype 2a [4] and a chimeric derivative of JFH-1 carrying 5'NTR and core sequences of HCV genotype 1a (Delgrange et al., unpublished data). Our data contrast with those obtained by others who concluded to relative siRNA-resistance of domains II [17] and III [17, 19] of HCV 5'NTR, incriminating the reduced accessibility of these domains given their association with different proteins and factors involved in translation. Our data thus indicate that regions involved in complex secondary and tertiary structures should not be disregarded as targets for RNAi and underline the importance of siRNA design [25, 26]. In contrast, two of the siRNAs tested in the present study (si214 and si284, targeting domain IIIc and IIIe, respectively) exhibited poor or only transient inhibitory effect on HCV RNA replication (Fig. 2a). Interestingly, siRNAs with sequence identical to that of si284 were reported to have discrepant effects in cells supporting autonomous replication of HCV subgenomic replicon in two other studies [13, 19]. These conflicting results may be explained by different strategies used for siRNA synthesis and/or delivery. In addition, the sensitivity of the replicon systems used may impact on the siRNA efficiencies reported.

We observed some differences in siRNA efficiencies between transient replication systems in which viral target RNA and siRNA were co-introduced into cells (Figs. 2, 4), and stable replication systems in which siRNA was introduced in cells supporting ongoing replication of the viral target, whether dealing with a subgenomic replicon (Fig. 3) or genome-length infectious RNA (Fig. 5, Table 2). Two μg siRNA did not inhibit viral RNA replication in the stable subgenomic replicon system as efficiently as in cotransfection experiments (compare Fig. 3 and Figs. 2, 4). In addition, si240-1a and si244 led to viral RNA elimination upon cotransfection with subgenomic replicon (Fig. 2a), while they substantially reduced, but did

not abolish virus particle production (Fig. 5, Table 2). This is in spite of the fact that the molar ratio of siRNA over targeted HCV RNA was higher in cells stably containing HCV replicons or infected with virus than in cells cotransfected with replicon and siRNA. In another study, high doses (4000 pmol) of siRNAs proved necessary to strongly inhibit HCV RNA replication in subgenomic replicon-containing cells [18]. We speculate that viral RNA templates engaged in the replicase complex and nascent RNAs are probably not as accessible to the RNAi machinery as transfected viral RNAs. Our data can also be explained in part by the existence of a proportion of cells in the culture that were infected or supported ongoing viral RNA replication but did not receive siRNA, given an electroporation efficiency of ~70% in En5-3 and 2-3c cells (data not shown).

The specificity of HCV siRNAs was demonstrated by studying their dose-effect responses (Fig. 2b), as well as by using si240 to target the replicon 5'NTR from two HCV genotypes (1a and 1b; Figs. 2-4) and si244 to target the 5'NTR of genotype 1a or 2a virus strains (Fig. 5, Table 2). When used with heterologous targets, siRNAs si240-1a and si240-1b exhibited a noncanonical wobble base-pairing or a mismatch at the 3' end (position 18) of the siRNA antisense strand, respectively (Fig. 1c). For both 1a and 1b replicons, perfect base-pairing was preferred for maximum RNAi efficacy, but a G:U wobble and an A:C mismatch were both tolerated (Fig. 4). This is consistent with the fact that wobble base-pairing is known to be well tolerated in dsRNA helices, providing similar stability as a Watson-Crick base-pairing. In agreement with our data, wobble base-pairs, especially when located at the 3' end of the siRNA antisense strand, were recently suggested to have no disruptive effect on RNAi [28, 29, 33]. More surprising, but also consistent with our data, it was reported that an A:C mismatch was not deleterious in dsRNA structures [29]. Contrasting with these tolerated

mismatches between siRNA and viral target RNA, we found that a C:A mismatch at the 5' end of the siRNA antisense strand strongly reduced the inhibitory effect of si244 on JFH-1 infection in cell culture (Fig. 5, Table 2), which is consistent with RNAi mechanism [29, 37]. Altogether, these data provide strong evidence against the involvement of a spurious interferon-mediated mechanism of inhibition in the suppression of viral replication observed. The sequence of RNA viruses, such as HCV, is known to continuously evolve, resulting in the production of many quasi-species, due to high error rate of RNA-dependent RNA polymerases with no proof-reading activity. This property allows RNA viruses to escape rapidly to a selective pressure such as antiviral treatments, when sequence changes are compatible with virus functions. This holds true for anti-protease and anti-polymerase compounds which are currently under development for HCV [38, 39]. However, we did not observe, after a single siRNA treatment, the emergence of escape mutations within siRNA-targeted genomic regions in RNA extracted from several G418-resistant cell clones. In other studies, siRNA-resistant viral mutants harboring single nucleotide substitutions or deletions within or at the vicinity of the siRNA-targeted sequence were reported to have emerged in cells expressing constitutively a shRNA, in the case of HIV infections [40, 41], or after repeated treatments with an siRNA targeting the polymerase coding sequence in the case of HCV subgenomic replicons [16]. The lack of escape mutations in our study could thus be linked to the use of a single siRNA treatment, or to the fact that siRNAs target highly conserved, functionally important genomic sequences, in which substitutions would not be compatible with translation/replication competence. Additional studies will be needed to discriminate between these hypotheses.

In the perspective of evaluating the potency of siRNA-based antiviral strategies to eradicate persistent infections, it was recently shown that siRNAs may be used to cure *in vitro* persistent infections by RNA viruses, such as poliovirus or lymphocytic choriomeningitis virus [30, 42]. To assay such a therapeutical strategy in animal models, synthetic siRNAs need to be further chemically-stabilized and formulated to be efficiently delivered. Successful utilization of stabilized, lipid-encapsulated siRNAs was reported in a mouse model of hepatitis B virus (HBV) replication [43]. In addition, organ or cell-type specific delivery of siRNAs has been achieved through siRNA binding to cholesterol [44] or to antibodies directed against cell surface antigens [45]. Synthetic shRNAs also showed more prolonged inhibitory effect than siRNAs in the liver of mice, as exemplified upon co-delivery of shRNA or siRNA targeting domain IV of the HCV IRES and plasmid DNA encoding a reporter protein placed under the translational control of the HCV IRES [46]. Alternatively, optimization of siRNA delivery may rely on the use of viral vectors allowing continuous synthesis of shRNAs in cells, leading to sustained RNAi [31, 47]. The control of intracellular shRNA production levels is, however, critical, since it has recently been reported that constant, high expression of shRNAs in the liver could be lethal in mouse models [48]. Nevertheless, controlled dose of siRNA or expression of shRNA have already proven efficient and safe in several animal models of viral infection, including in a mouse model of HBV infection [47], a rhesus macaque model of Severe Acute Respiratory Syndrome associated coronavirus infection [49], and mouse models of West Nile virus or Japanese encephalitis virus infection [31].

In the present study, we have identified promising anti-HCV siRNAs (si313 and to a lesser extent si244, si240) that target highly conserved sequences in domain III of the 5'NTR and

efficiently silence HCV infection in cell culture. It becomes now possible to monitor the effect of these siRNAs *in vivo* using a tamarin / marmoset primate model of infection with a chimeric GB virus B containing HCV domain III of the HCV IRES, that we have previously described [8].

Note added in proof: During revision of this manuscript, Kanda et al. (J. Virol. 2007, 81:669) reported that delivery of an HCV 5'NTR-specific shRNA to hepatoma cell lines infected by HCV resulted in the reduction of viral production.

MATERIALS & METHODS

Cells and viruses. Hepatoma cell lines, 2-3c [32], En5-3 [21], and HuAP are derived from the hepatocarcinoma cell line Huh7, and were cultured in Dulbecco's modified Eagle medium (Invitrogen, Cergy-Pontoise, France) supplemented with 10% fetal calf serum, 100U/mL penicillin and 100µg/mL streptomycin. En5-3 cells stably express secreted alkaline phosphatase (SEAP) under the control of the HIV LTR promoter [21], and were cultured in the presence of 2µg/mL blasticidin (InvivoGen, Toulouse, France). En5-3 cells supporting autonomous replication of Ntat2ANeo HCV replicon were cultured in the presence of 2µg/mL blasticidin and 0,5mg/mL geneticin (G418, Invitrogen, Cergy-Pontoise, France). Genotype 2a JFH-1 and chimeric JFH-1/C(+)-6-1a virus stocks were generated by transfection of HuAP cells with corresponding *in vitro* transcribed genomic RNAs. Plasmid pJFH-1 containing the genome-length cDNA of the JFH-1 isolate of HCV genotype 2a [Genbank accession number AB047639, Ref. 4] was generously provided by T. Wakita. Plasmid pJFH-1/C(+)-6-1a was derived from pJFH-1 by substituting nucleotides 154-341 of the 5' nontranslated region, as well as the capsid coding sequence by corresponding sequences of the H77 strain of genotype 1a (Delgrange et al., will be described elsewhere). Plasmids pJFH-1 and pJFH-1/C(+)-6-1a were linearized with XbaI and treated with Mung Bean nuclease prior to *in vitro* transcription using MEGAscript™ kit (Ambion, Cambridgeshire, United Kingdom). HuAP cells were electroporated with *in vitro* transcribed RNA, as previously described [50], and supernatants collected 8-10 days post-transfection were used to re-infect naïve HuAP cells. Supernatants collected at 10 days post-infection (p.i.) were used as virus stocks and stored at -80°C.

Design and synthesis of siRNAs. siRNAs targeting HCV IRES were designed using previously described criteria [25, 26]. The sequence of the sense-strand of each siRNA selected is shown in Table 1. siRNAs are referred to by the nucleotide position within the genome of the H77 strain of HCV genotype 1a [27] that corresponds to the first nucleotide targeted by the siRNA antisense strand. si240 was synthesized with a sequence homologous to HCV subtype 1a or 1b, i.e. containing a U (si240-1a) or a C (si240-1b) residue at position 18 of the siRNA antisense strand. An irrelevant siRNA, named siIRR, targets the 5'NTR of the Sabin strain of poliovirus type 3 [30] and was used as negative control in this study. The sequence of all siRNAs was compared to known genes by a BLAST search within the GenBank database and no significant homology to other genes was found. The two strands of each siRNA were chemically synthesized at the Institut Pasteur ("Plate-forme 7") and annealed at a final concentration of 500 pmol/ μ L, as previously described [25]. The quality and quantity of hybridized siRNAs were analyzed by electrophoresis on nondenaturing 3% agarose gels.

HCV subgenomic replicons and *in vitro* transcriptions. Two dicistronic, subgenomic HCV replicons that encode a selectable reporter gene, neomycine phosphotransferase (Neo) were used in this study (see Fig. 1). These replicon cDNAs, kindly provided by S.M. Lemon, are inserted downstream of the T7 RNA polymerase promoter and have been previously described as pNNeo/3-5B [20] and pNtat2Aneo [21]. We will refer to these replicons as NNeo and Ntat2Aneo, respectively, in this study. NNeo and Ntat2Aneo each carry a cell culture adaptive mutation, R2889G and S2005I, respectively. Both replicon cDNAs are derived from the cDNA of the N strain of genotype 1b HCV with the exception of the 5'NTR sequence of the Ntat2Aneo, which is derived from the H77 strain of HCV genotype 1a.

Ntat2ANeo RNA encodes HIV Tat protein fused to the 2A protease of foot-and-mouth disease virus (FMDV) followed by Neo [21]. Upon transfection of En5-3 cells with Ntat2ANeo replicon, the expression of Tat-2A drives the synthesis of secreted SEAP [21]. cDNAs bearing a 30-nucleotide deletion including the 3 codons (GDD) of the active site of the RNA polymerase NS5B within the backbone of NNeo and Ntat2ANeo [20, 21], referred to as Δ GDD, were used as replication-deficient RNAs. Plasmid DNAs were linearized with *Xba*I prior to *in vitro* transcription using T7 MEGAscript reagents (Ambion, Cambridgeshire, United Kingdom). DNA template was removed by treatment with Turbo DNase (Ambion, Cambridgeshire, United Kingdom) and RNAs were purified by phenol-chloroform extractions and precipitated with ethanol. The quality and quantity of replicon RNAs were analyzed by electrophoresis on a non-denaturing 0.8% agarose gel and by optical density measurements.

Cell transfections. En5-3 or 2-3c cells (2×10^6) were electroporated with 5 μ g replicon RNA, or co-electroporated with 5 μ g replicon RNA and various doses of each siRNA, in a 4 mm-gap width cuvette by applying one pulse at 240V, 900 μ F (EasyjecT Plus, Geneflow Ltd, Staffordshire, United Kingdom). Cells were resuspended in complete medium immediately after the pulse and seeded at various concentrations. En5-3 cells supporting autonomous replication of Ntat2ANeo replicon were similarly transfected by electroporation with each siRNA.

Measurement of SEAP activity. En5-3 transfected cells (4×10^5) were seeded in 6-well plates and supernatants were collected at 1, 2, 3, 4 and 7 days after electroporation and replaced with fresh medium. SEAP activity was measured in supernatant aliquots with the Phospha-Light™ System (Applied Biosystems/ Tropix, Courtaboeuf, France) using a luminescent

substrate according to the manufacturer's recommendations. Luminescent signals were read for 1 s using a Lumat LB 9507 luminometer (Berthold Technologies, Thoiry, France).

G418-resistant cell clone selection. To select for G418-resistant cell clones, variable fractions of 2-3c transfected cells were seeded in 100 mm-diameter dishes and supplemented with NNeo- Δ GDD or Ntat2ANeo- Δ GDD transfected cells to adjust the final number of cells to 5×10^5 cells per dish. Twenty-four to 48 hours following transfection, cells were placed under the selective pressure of 0.5 mg/mL geneticin (G418, Invitrogen, Cergy-Pontoise, France) for 3 weeks, with medium replacement twice a week. G418-resistant cell clones supporting viral RNA replication were fixed and stained with a 0.1% crystal violet solution, or selected and expanded under selective pressure for viral RNA sequencing.

Viral RNA sequencing. Total RNA was extracted from expanded siRNA-resistant clones with TRIzol reagent (Invitrogen, Cergy-Pontoise, France). Viral RNA was reverse transcribed and amplified with HCV specific primers designed to generate PCR products spanning nucleotides (nts) 100 to 451, using the SuperScript One-Step RT-PCR kit with Platinum Taq (Invitrogen, Cergy-Pontoise, France). Sequencing reactions were carried out on uncloned RT-PCR products using Big Dye Terminator version 1.1 kit (Applied Biosystems, Courtaboeuf, France) and analysed on a ABI 3700 capillary DNA sequencer (Applied Biosystems, Courtaboeuf, France).

Detection of viral RNA by semi-quantitative RT-PCR. En 5-3 transfected cells (2×10^5) were seeded in 6-well plates (duplicate wells per transfection) and cultured for 4 days, then trypsinized and passaged at a 1:5 dilution in new 6-well plates. At day 10 post-transfection, total RNA was extracted independently from duplicate wells using RNeasy mini kit (Qiagen, Courtaboeuf, France). Five micrograms of total cellular RNA were heat-denatured at 65°C for

5 min and used as template for reverse transcription with 50 U of Superscript II reverse transcriptase (Invitrogen, Cergy-Pontoise, France) and 250 ng of random hexanucleotide primers (Roche, Meylan, France) for 50 min at 42°C. Resulting cDNAs were treated with 2 U of RNaseH (Invitrogen, Cergy-Pontoise, France) for 30 min at 37°C, and purified using QIAquick PCR purification kit (Qiagen, Courtaboeuf, France). One fifth of the cDNA was used to program PCR reactions with either HCV-specific primers that allowed amplification of a fragment spanning nts 3457-5085 of the N strain of HCV genotype 1b, or primers specific for cellular housekeeping gene glyceraldehyde-3-phosphate dehydrogenase (GAPDH), to normalize for total RNA content. PCR reactions were performed using Platinum *Taq* DNA polymerase (Invitrogen, Cergy-Pontoise, France) under the following cycling conditions : 1 cycle at 94°C for 3 min, followed by 35 cycles of : 30 s at 94°C ; 30 s at 55°C ; 1.5 min at 72°C. PCR products were analyzed by electrophoresis on 1% agarose gels.

Infection with HCV and indirect immunofluorescence analysis. HuAP cells (4×10^6) were electroporated with 2 μ g of siRNA, and 5×10^4 electroporated cells were seeded on coverslips in 24-well plates and subsequently infected at 16 h post-transfection with JFH-1 or JFH-1/C(+)-6-1a virus stocks at ~ 1 FFU per cell. After a 2 h incubation at 37°C, virus inoculum was washed off and cells were fed with culture medium. At 42 h p.i., cells were fixed and processed for core detection by indirect immunofluorescence, as previously described [50], using anti-core monoclonal antibody (Mab) ACAP27 (kindly provided by J.F. Delagneau, Bio-Rad, France). Cells were counterstained with Hoechst dye to detect nuclei. For titration of infectious viral particles, 5×10^4 HuAP cells were infected with 1:10 dilutions of supernatants from cells transfected with siRNAs and infected with HCV. Foci of infected

cells were detected by immunofluorescence with anti-core Mab at 72 h p.i. and counted to determine titers in FFU/mL.

Immunoblot analysis of HCV-infected cells. HuAP cells (4×10^6) seeded in 24-well plates were lysed in 50 mM Tris HCl (pH 7.5), 150 mM NaCl, 5 mM EDTA, 0.5% (v/v) Igepal buffer containing a mixture of protease inhibitors (Complete, Roche, Meylan, France) and processed for E2 or β -actin detection by immunoblot analysis as previously described [50], using anti-E2 MAb 3/11 [51] or anti- β -actin Mab (Sigma-Aldrich, Saint Quentin Fallavier, France), respectively.

Quantification of virus production by quantitative RT-PCR. Viral RNAs were isolated from cell culture supernatants using QIAamp Viral RNA kit (Qiagen, Courtaboeuf, France) and quantified by real-time TaqMan RT-PCR using primer pair and probe targeting a sequence spanning nts 130 to 290 within the HCV 5'NTR : FP 5'-CGGGAGAGCCATAGTGG -3' ; RP 5'- AGTACCACAAGGCCTTTCG -3' ; Probe 5'-FAM- CTGCGGAACCGGTGAGTACAC -TAMRA -3'. Assays were performed using Taqman One-Step RT-PCR Master Mix Reagents and an ABI PRISM 7700 Sequence Detector instrument (Applied Biosystems, Courtaboeuf, France), according to the manufacturer's instructions.

Acknowledgments

This work was supported in part by grants from the Institut Pasteur (Applications de la Recherche et des Relations Industrielles), the French National Agency for Research on AIDS and Viral Hepatitis (ANRS), and the National Institutes of Health, USA (R24-RR15081). C.C. was the recipient of a fellowship from the Foundation Pasteur-Weizmann. A.S. was the recipient of a PhD fellowship from the French Ministry of Research (MENESR), then a post-doctoral fellowship from ANRS. The authors gratefully acknowledge André Pillez (I.B.L., Lille, France) for technical assistance, Catherine Gouyette (Plate-forme 7, Institut Pasteur, Paris, France) for the synthesis of siRNAs, MinKyung Yi, Masanori Ikeda and Stanley M. Lemon (University of Texas Medical Branch, Galveston, TX, USA) for the gift of HCV replicons and cells, Jean-François Delagneau (Bio-Rad, Paris, France) and Jane McKeating (University of Birmingham Medical School, Birmingham, U.K.) for the gift of HCV antibodies, and Takaji Wakita (National Institute of Infectious Diseases, Tokyo, Japan) for the gift of JFH-1 cDNA. We are grateful to Stanley Lemon for critical reading of the manuscript, and to Sylvie van der Werf (Institut Pasteur, Paris, France) for continuous support.

REFERENCES

1. Bartenschlager, R, Frese, M, and Pietschmann, T (2004). Novel insights into hepatitis C virus replication and persistence. *Adv Virus Res*; **63**: 71-180.
2. Rijnbrand, RC, and Lemon, SM (2000). Internal ribosome entry site-mediated translation in hepatitis C virus replication. *Curr Top Microbiol Immunol*; **242**: 85-116.
3. Lohmann, V, Korner, F, Koch, J, Herian, U, Theilmann, L, and Bartenschlager, R (1999). Replication of subgenomic hepatitis C virus RNAs in a hepatoma cell line. *Science*; **285**: 110-113.
4. Wakita, T, Pietschmann, T, Kato, T, Date, T, Miyamoto, M, Zhao, Z, et al. (2005). Production of infectious hepatitis C virus in tissue culture from a cloned viral genome. *Nat Med*; **11**: 791-796.
5. Mercer, DF, Schiller, DE, Elliott, JF, Douglas, DN, Hao, C, Rinfret, A, et al. (2001). Hepatitis C virus replication in mice with chimeric human livers. *Nat Med*; **7**: 927-933.
6. Lanford, RE, Chavez, D, Notvall, L, and Brasky, KM (2003). Comparison of tamarins and marmosets as hosts for GBV-B infections and the effect of immunosuppression on duration of viremia. *Virology*; **311**: 72-80.
7. Martin, A, Bodola, F, Sangar, DV, Goettge, K, Popov, V, Rijnbrand, R, et al. (2003). Chronic hepatitis associated with GB virus B persistence in a tamarin after intrahepatic inoculation of synthetic viral RNA. *Proc Natl Acad Sci U S A*; **100**: 9962-9967.
8. Rijnbrand, R, Yang, Y, Beales, L, Bodola, F, Goettge, K, Cohen, L, et al. (2005). A chimeric GB virus B with 5' nontranslated RNA sequence from hepatitis C virus causes hepatitis in tamarins. *Hepatology*; **41**: 986-994.
9. Dykxhoorn, DM, and Lieberman, J (2005). The silent revolution: RNA interference as

- basic biology, research tool, and therapeutic. *Annu Rev Med*; **56**: 401-423.
10. Colbère-Garapin, F, Blondel, B, Saulnier, A, Pelletier, I, and Labadie, K (2005). Silencing viruses by RNA interference. *Microbes Infect*; **7**: 767-775.
 11. Leonard, JN, and Schaffer, DV (2006). Antiviral RNAi therapy: emerging approaches for hitting a moving target. *Gene Ther*; **13**: 532-540.
 12. Grimm, D, and Kay, MA (2006). Therapeutic short hairpin RNA expression in the liver: viral targets and vectors. *Gene Ther*; **13**: 563-575.
 13. Seo, MY, Abrignani, S, Houghton, M, and Han, JH (2003). Small interfering RNA-mediated inhibition of hepatitis C virus replication in the human hepatoma cell line Huh-7. *J Virol*; **77**: 810-812.
 14. Kapadia, SB, Brideau-Andersen, A, and Chisari, FV (2003). Interference of hepatitis C virus RNA replication by short interfering RNAs. *Proc Natl Acad Sci U S A*; **100**: 2014-2018.
 15. Yokota, T, Sakamoto, N, Enomoto, N, Tanabe, Y, Miyagishi, M, Maekawa, S, et al. (2003). Inhibition of intracellular hepatitis C virus replication by synthetic and vector-derived small interfering RNAs. *EMBO Rep*; **4**: 602-608.
 16. Wilson, JA, and Richardson, CD (2005). Hepatitis C virus replicons escape RNA interference induced by a short interfering RNA directed against the NS5b coding region. *J Virol*; **79**: 7050-7058.
 17. Krönke, J, Kittler, R, Buchholz, F, Windisch, MP, Pietschmann, T, Bartenschlager, R, et al. (2004). Alternative approaches for efficient inhibition of hepatitis C virus RNA replication by small interfering RNAs. *J Virol*; **78**: 3436-3446.
 18. Randall, G, Grakoui, A, and Rice, CM (2003). Clearance of replicating hepatitis C virus replicon RNAs in cell culture by small interfering RNAs. *PrProc Natl Acad Sci U S A*; **100**:

235-240.

19. Takigawa, Y, Nagano-Fujii, M, Deng, L, Hidajat, R, Tanaka, M, Mizuta, H, et al. (2004). Suppression of hepatitis C virus replicon by RNA interference directed against the NS3 and NS5B regions of the viral genome. *Microbiol Immunol*; **48**: 591-598.
20. Ikeda, M, Yi, M, Li, K, and Lemon, SM (2002). Selectable subgenomic and genome-length dicistronic RNAs derived from an infectious molecular clone of the HCV-N strain of hepatitis C virus replicate efficiently in cultured Huh7 cells. *J Virol*; **76**: 2997-3006.
21. Yi, M, Bodola, F, and Lemon, SM (2002). Subgenomic hepatitis C virus replicons inducing expression of a secreted enzymatic reporter protein. *Virology*; **304**: 197-210.
22. Spahn, CM, Kieft, JS, Grassucci, RA, Penczek, PA, Zhou, K, Doudna, JA, et al. (2001). Hepatitis C virus IRES RNA-induced changes in the conformation of the 40s ribosomal subunit. *Science*; **291**: 1959-1962.
23. Kieft, JS, Zhou, K, Jubin, R, and Doudna, JA (2001). Mechanism of ribosome recruitment by hepatitis C IRES RNA. *RNA*; **7**: 194-206.
24. Friebe, P, Lohmann, V, Krieger, N, and Bartenschlager, R (2001). Sequences in the 5' nontranslated region of hepatitis C virus required for RNA replication. *J Virol*; **75**: 12047-12057.
25. Elbashir, SM, Harborth, J, Weber, K, and Tuschl, T (2002). Analysis of gene function in somatic mammalian cells using small interfering RNAs. *Methods*; **26**: 199-213.
26. Reynolds, A, Leake, D, Boese, Q, Scaringe, S, Marshall, WS, and Khvorova, A (2004). Rational siRNA design for RNA interference. *Nat Biotechnol*; **22**: 326-330.
27. Yanagi, M, Purcell, RH, Emerson, SU, and Bukh, J (1997). Transcripts from a single full-length cDNA clone of hepatitis C virus are infectious when directly transfected into the

- liver of a chimpanzee. *Proc Natl Acad Sci U S A*; **94**: 8738-8743.
28. Doench, JG, Petersen, CP, and Sharp, PA (2003). siRNAs can function as miRNAs. *Genes Dev*; **17**: 438-442.
29. Du, Q, Thonberg, H, Wang, J, Wahlestedt, C, and Liang, Z (2005). A systematic analysis of the silencing effects of an active siRNA at all single-nucleotide mismatched target sites. *Nucleic Acids Res*; **33**: 1671-1677.
30. Saulnier, A, Pelletier, I, Labadie, K, and Colbère-Garapin, F (2006). Complete cure of persistent virus infections by antiviral siRNAs. *Mol Ther*; **13**: 142-150.
31. Kumar, P, Lee, SK, Shankar, P, and Manjunath, N (2006). A single siRNA suppresses fatal encephalitis induced by two different flaviviruses. *PLoS Med*; **3**: e96.
32. Scholle, F, Li, K, Bodola, F, Ikeda, M, Luxon, BA, and Lemon, SM (2004). Virus-host cell interactions during hepatitis C virus RNA replication: impact of polyprotein expression on the cellular transcriptome and cell cycle association with viral RNA synthesis. *J Virol*; **78**: 1513-1524.
33. Martinez, J, and Tuschl, T (2004). RISC is a 5' phosphomonoester-producing RNA endonuclease. *Genes Dev*; **18**: 975-980.
34. Simmonds, P (2004). Genetic diversity and evolution of hepatitis C virus--15 years on. *J Gen Virol*; **85**: 3173-3188.
35. Lukavsky, PJ, Otto, GA, Lancaster, AM, Sarnow, P, and Puglisi, JD (2000). Structures of two RNA domains essential for hepatitis C virus internal ribosome entry site function. *Nat Struct Biol*; **7**: 1105-1110.
36. Boehringer, D, Thermann, R, Ostareck-Lederer, A, Lewis, JD, and Stark, H (2005). Structure of the hepatitis C Virus IRES bound to the human 80S ribosome: remodeling of the

HCV IRES. *Structure*; **13**: 1695-1706.

37. Doench, JG, and Sharp, PA (2004). Specificity of microRNA target selection in translational repression. *Genes Dev*; **18**: 504-511.

38. Kneteman, NM, Weiner, AJ, O'Connell, J, Collett, M, Gao, T, Aukerman, L, et al. (2006). Anti-HCV therapies in chimeric scid-Alb/uPA mice parallel outcomes in human clinical application. *Hepatology*; **43**: 1346-1353.

39. Mo, H, Lu, L, Pilot-Matias, T, Pithawalla, R, Mondal, R, Masse, S, et al. (2005). Mutations conferring resistance to a hepatitis C virus (HCV) RNA-dependent RNA polymerase inhibitor alone or in combination with an HCV serine protease inhibitor in vitro. *Antimicrob Agents Chemother*; **49**: 4305-4314.

40. Das, AT, Brummelkamp, TR, Westerhout, EM, Vink, M, Madiredjo, M, Bernards, R, et al. (2004). Human immunodeficiency virus type 1 escapes from RNA interference-mediated inhibition. *J Virol*; **78**: 2601-2605.

41. Westerhout, EM, Ooms, M, Vink, M, Das, AT, and Berkhout, B (2005). HIV-1 can escape from RNA interference by evolving an alternative structure in its RNA genome. *Nucleic Acids Res*; **33**: 796-804.

42. Sanchez, AB, Perez, M, Cornu, T, and de la Torre, JC (2005). RNA interference-mediated virus clearance from cells both acutely and chronically infected with the prototypic arenavirus lymphocytic choriomeningitis virus. *J Virol*; **79**: 11071-11081.

43. Morrissey, DV, Lockridge, JA, Shaw, L, Blanchard, K, Jensen, K, Breen, W, et al. (2005). Potent and persistent in vivo anti-HBV activity of chemically modified siRNAs. *Nat Biotechnol*; **23**: 1002-1007.

44. Soutschek, J, Akinc, A, Bramlage, B, Charisse, K, Constien, R, Donoghue, M, et al.

- (2004). Therapeutic silencing of an endogenous gene by systemic administration of modified siRNAs. *Nature*; **432**: 173-178.
45. Song, E, Zhu, P, Lee, SK, Chowdhury, D, Kussman, S, Dykxhoorn, DM, et al. (2005). Antibody mediated in vivo delivery of small interfering RNAs via cell-surface receptors. *Nat Biotechnol*; **23**: 709-717.
46. Wang, Q, Contag, CH, Ilves, H, Johnston, BH, and Kaspar, RL (2005). Small hairpin RNAs efficiently inhibit hepatitis C IRES-mediated gene expression in human tissue culture cells and a mouse model. *Mol Ther*; **12**: 562-568.
47. Uprichard, SL, Boyd, B, Althage, A, and Chisari, FV (2005). Clearance of hepatitis B virus from the liver of transgenic mice by short hairpin RNAs. *Proc Natl Acad Sci U S A*; **102**: 773-778.
48. Grimm, D, Streetz, KL, Jopling, CL, Storm, TA, Pandey, K, Davis, CR, et al. (2006). Fatality in mice due to oversaturation of cellular microRNA/short hairpin RNA pathways. *Nature*; **441**: 537-541.
49. Li, BJ, Tang, Q, Cheng, D, Qin, C, Xie, FY, Wei, Q, et al. (2005). Using siRNA in prophylactic and therapeutic regimens against SARS coronavirus in Rhesus macaque. *Nat Med*; **11**: 944-951.
50. Rouille, Y, Helle, F, Delgrange, D, Roingeard, P, Voisset, C, Blanchard, E, et al. (2006). Subcellular localization of hepatitis C virus structural proteins in a cell culture system that efficiently replicates the virus. *J Virol*; **80**: 2832-2841.
51. Flint, M, Thomas, JM, Maidens, CM, Shotton, C, Levy, S, Barclay, WS, et al. (1999). Functional analysis of cell surface-expressed hepatitis C virus E2 glycoprotein. *J Virol*; **73**: 6782-6790.

siRNA ¹	siRNA sense-strand (5' ^ 3')	Conservation degree (%) ²
si205	CCCGCUCAAUGCCUGGAGATT	73.6
si214	UGCCUGGAGAUUUGGGCGUTT	73.6
si240-1a	CAAGACUGCUAGCCGAGUATT	28.9
si240-1b	CGAGACUGCUAGCCGAGUATT	62.3
si244	ACUGCUAGCCGAGUAGUGUTT	71.1
si284	GUACUGCCUGAUAGGGUGCTT	98.7
si313	CCCGGGAGGUCUCGUAGACTT	98.1
siIRR	CGUUUUACUCCUUAACUUATT	NA

Table 1 : Sequences of siRNAs used to target domain III of the internal ribosome entry site of HCV genome.

¹ siRNA numbering corresponds to the first nucleotide of the H77 strain of HCV genotype 1a [27] targeted by the 21-nucleotide siRNA antisense-strand.

² Degree of conservation (%) of each siRNA-targeted sequence among 159 HCV sequences of all genotypes, as found in the Los Alamos National Laboratory database (<http://hcv.lanl.gov/content/hcv-db/index>). NA: not applicable

siRNA	Virus production ¹	
	JFH-1	JFH-1/C(+) 6-1a
Ø	8.4 × 10 ³ (100)	7.1 × 10 ³ (100)
siIRR	7.8 × 10 ³ (93)	6.6 × 10 ³ (93)
si240-1a	2.9 × 10 ³ (35)	1.0 × 10 ³ (14)
si244	5.1 × 10 ³ (61)	1.1 × 10 ³ (15)
si313	1.5 × 10 ² (2)	3.0 × 10 ² (4)

Table 2 : Effect of siRNAs on HCV production.

¹ Viral titers in the supernatants of HuAP cells transfected with each siRNA and infected with the indicated virus are expressed in FFU/mL, as well as, in parentheses (%) relative to virus production from mock-transfected cultures (Ø) set at 100%.

FIGURE LEGENDS

Figure 1 : HCV-specific siRNAs and HCV replicons used.

(a) The footprints of the 7 HCV-specific siRNAs selected to target the IRES are represented on the schematic structure of domains III-IV of the 5'NTR from the H77 strain of HCV genotype 1a [2]. siRNA si240 targets a viral sequence that contains a nucleotide change in HCV genotype 1a and 1b sequences, as indicated. (b) The two replicons used in this study, Ntat2ANeo [21] and NNeo [20] with 5'NTRs derived from HCV genotype 1a and 1b strains, respectively, are schematically represented, with cell culture adaptive mutations (S2005I in NS5A and R2889G in NS5B, respectively) indicated by arrowheads. Both replicons encode neomycine phosphotransferase (Neo) C-terminally fused to either HIV Tat protein followed by foot and mouth disease virus (FMDV) autocatalytically cleaved 2A protein (Ntat2ANeo) or to a few amino acid residues from core protein (Δ C in NNeo). (c) The base pairing of si240-1a and si240-1b with 5'NTR sequences of replicons Ntat2ANeo (1a genotype) and NNeo (1b genotype), and of si244 with 5'NTR sequence of virus JFH-1 (2a genotype) is shown. Viral RNA/siRNA duplexes are delineated by dotted lines. Nucleotide mismatches between siRNAs and HCV sequences are boxed and their position within the siRNA anti-sense strand is indicated.

Figure 2 : siRNAs inhibit efficiently transient replication of reporter HCV replicon.

(a) Graphs represent secreted phosphatase alkaline (SEAP) activities (arbitrary units) in supernatants of En5-3 cell cultures electroporated with no RNA (Mock), 5 μ g RNA from HCV Ntat2ANeo replicon (Ntat2ANeo) or a non-replicative HCV RNA (Δ GDD), or

coelectroporated with 5 μ g of HCV Ntat2ANeo replicon and 2 μ g of each indicated siRNA. Each time point corresponds to the amount of SEAP accumulated over 24-hour periods during the first 4 days after transfection, and the last point at 7 days post-transfection corresponds to SEAP activity accumulated between days 4 and 7 post-transfection. Each point represents mean \pm standard deviation of at least 3 experiments. Data are represented on a logarithmic scale. (b) Effects of increasing doses of each siRNA (white to dark grey bars for 4 to 2000 ng doses) are represented as percentages of SEAP activity inhibition, calculated relatively to SEAP activity obtained with replicon Ntat2ANeo RNA alone. Each histogram bar represents mean \pm standard deviation of multiple independent experiments. (c) Identical amounts of total RNA extracted from cells transfected with no RNA (Mock), HCV Ntat2ANeo replicon (Ntat2ANeo), or non-replicative HCV RNA (Δ GDD), or coelectroporated with 5 μ g of HCV Ntat2ANeo replicon and 2 μ g of each indicated siRNA were reverse transcribed and amplified by PCR using HCV 5'NTR-specific primers (upper gel) or housekeeping gene GAPDH-specific primers (lower gel). A control reaction performed in the absence of template RNA (No RNA) was analyzed in parallel on 1% agarose gels. PCR products obtained with RNA extracted from two independent cell cultures treated with HCV-specific siRNAs are shown. DNA molecular weight markers are shown on the left of the gels. Filled and open arrowheads point to HCV and GAPDH-specific RT-PCR products, respectively.

Figure 3 : Inhibitory effect of siRNA treatment in cells supporting autonomous replication of HCV replicon.

SEAP activities in supernatants of En5-3 cells supporting autonomous replication of Ntat2ANeo replicon transfected with 2 μ g of each indicated siRNA were determined at 7 days post-transfection and represented relative to SEAP activity present in mock-transfected cells, set at 100%. Each bar represents mean \pm standard deviation of 4 experiments.

Figure 4 : siRNAs protect from establishment of HCV replicon-containing cell clones.

(a) Numbers of G418-resistant 2-3c cell clones obtained 3 weeks after cotransfection of 5 μ g of Ntat2ANeo or NNeo replicon and 2 μ g of each indicated siRNA that is homologous to both HCV replicons (si205, si244, si313) or irrelevant siRNA (siIRR) are expressed relative to 10,000 resistant cell clones obtained after transfection of HCV replicon alone (\emptyset). Values (means \pm standard deviations of independent transfections) are plotted on a logarithmic scale. The effects of si240-1a or si240-1b treatment on replicon Ntat2ANeo (b) and NNeo (c) are represented separately. Mismatches present at position 18 of the siRNA antisense strand are indicated on top of the bars corresponding to heterologous targets.

Figure 5 : HCV 5'NTR-specific siRNAs silence virus replication in cell culture.

(a) HuAP cells were transfected with no siRNA (\emptyset), irrelevant siRNA (siIRR) or the indicated HCV-specific siRNA (si240-1a, si244, si313), then infected at 16 h post-transfection with either JFH-1 strain of HCV genotype 2a (right panels) or a chimeric JFH-1 virus containing 5'NTR-C sequences from the H77 strain of HCV genotype 1a (JFH-1/C(+)-6-1a, left panels). At 42 h p.i., cells were fixed and processed for core detection by

immunofluorescence and counterstained with Hoechst dye to visualize nuclei. Overlaid images (x10) are shown. Control cells that were mock-transfected and mock-infected (Mock) were processed in parallel. (b) Extracts from siRNA-transfected and HCV-infected cells collected at 42 h p.i. were analyzed by western blotting for expression of E2 glycoprotein (upper gel) and cellular β -actin (lower gel) as loading controls. (c) Virus yields in supernatants from siRNA-transfected and HCV-infected cells collected at 42 h p.i. were quantified in genome equivalents /mL by real-time TaqMan RT-PCR and expressed relative to virus production in the absence of siRNA treatment, set at 100% (mean \pm standard deviation of duplicates in 2 independent experiments).

a. III HCV-1a

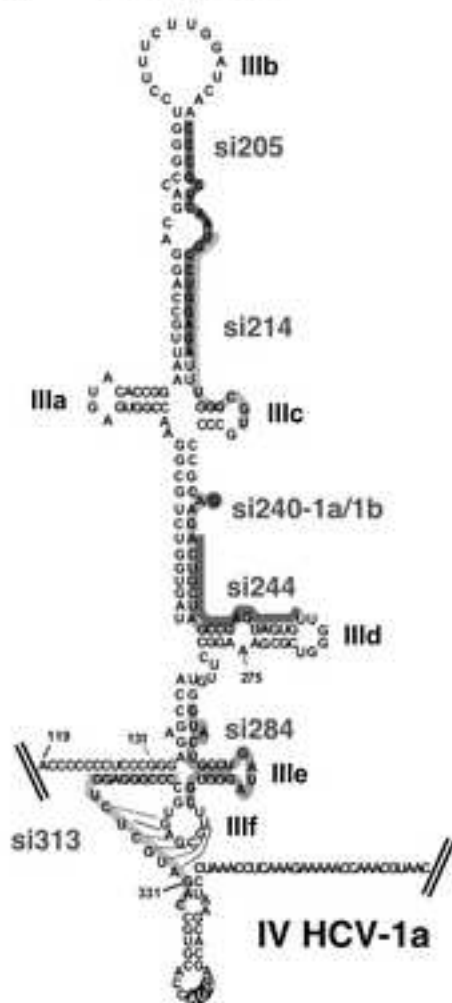

b.

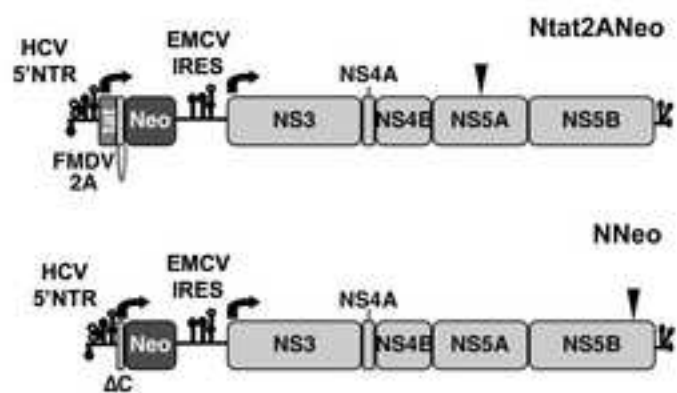

c.



Figure 2

[Click here to download high resolution image](#)

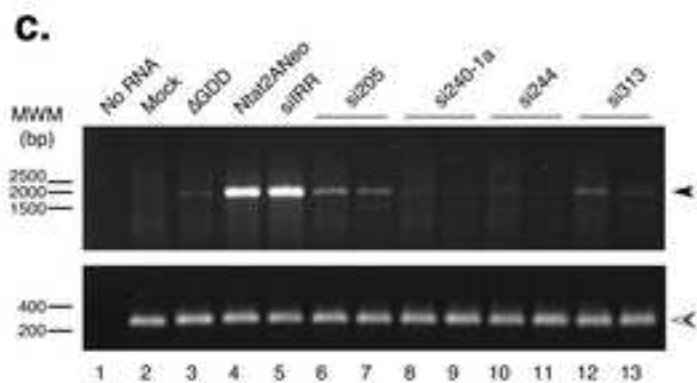
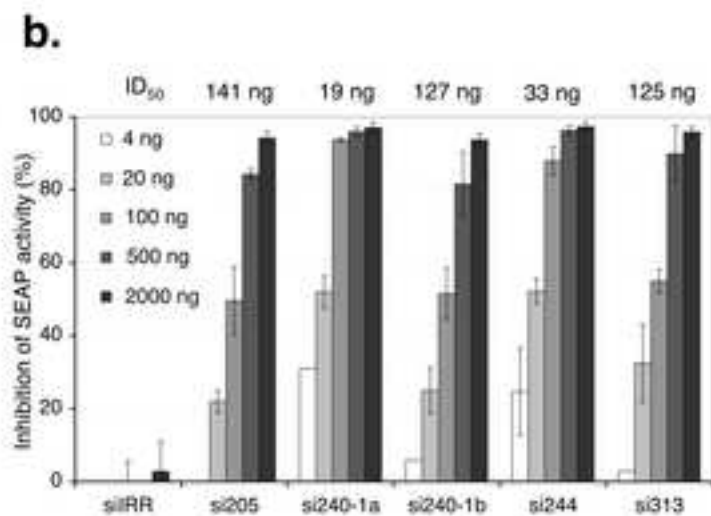
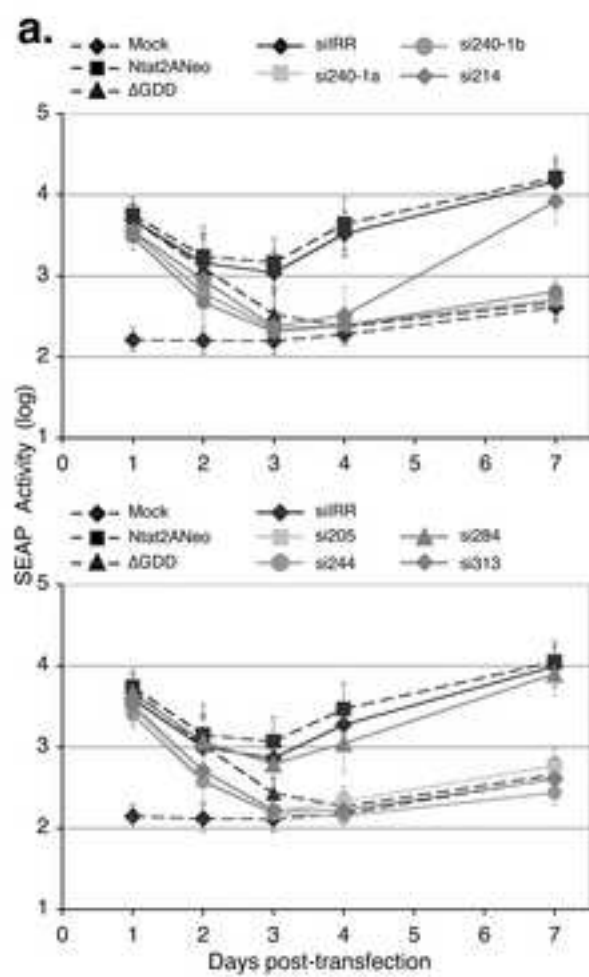

Figure 3
[Click here to download high resolution image](#)

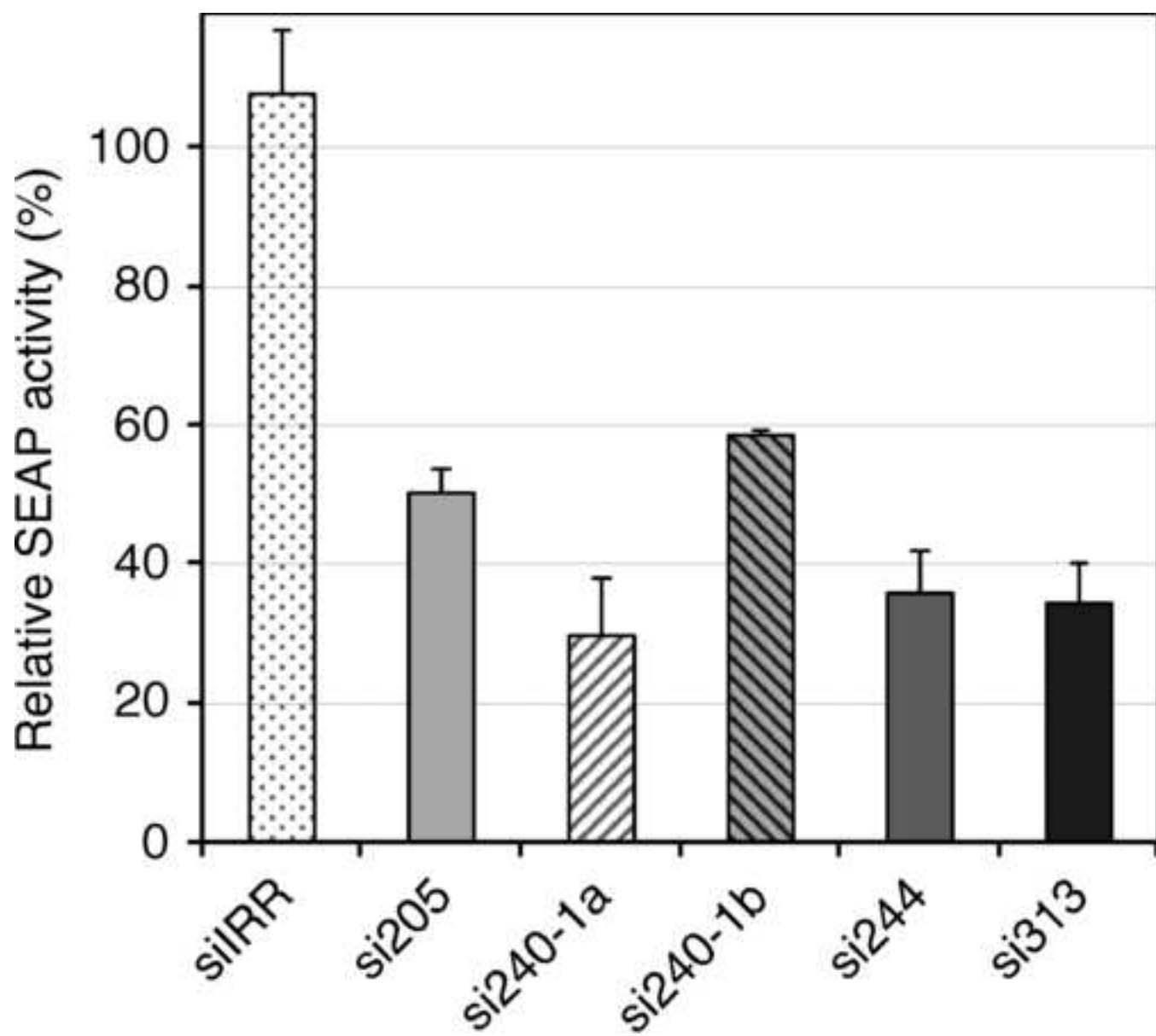
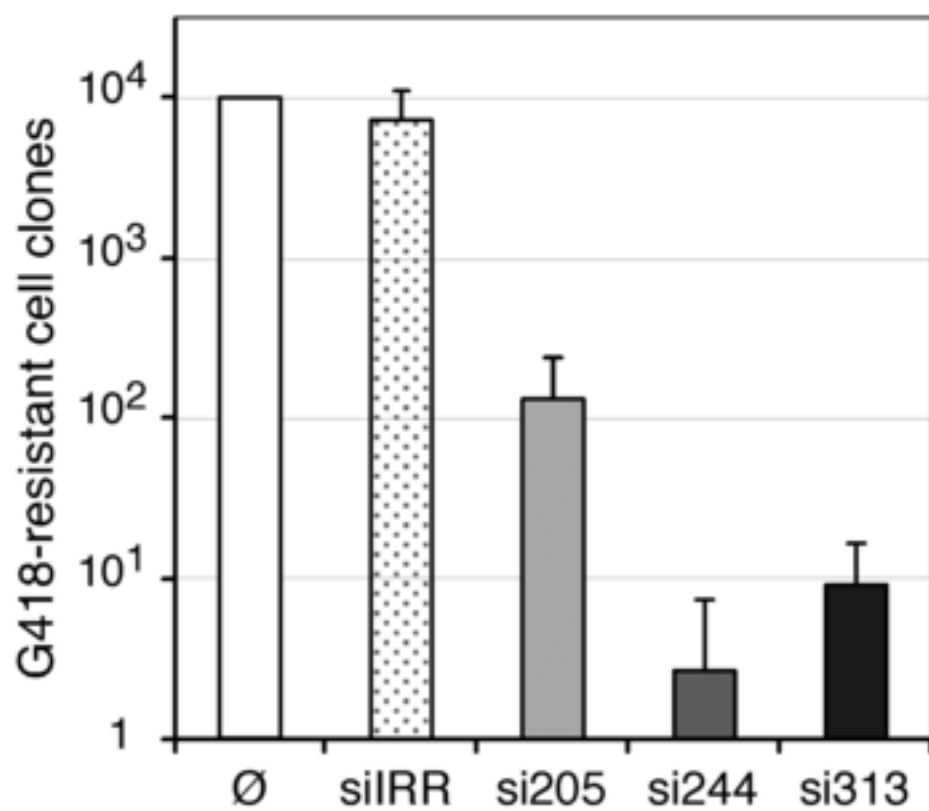

Figure 4
[Click here to download high resolution image](#)

a.



b.

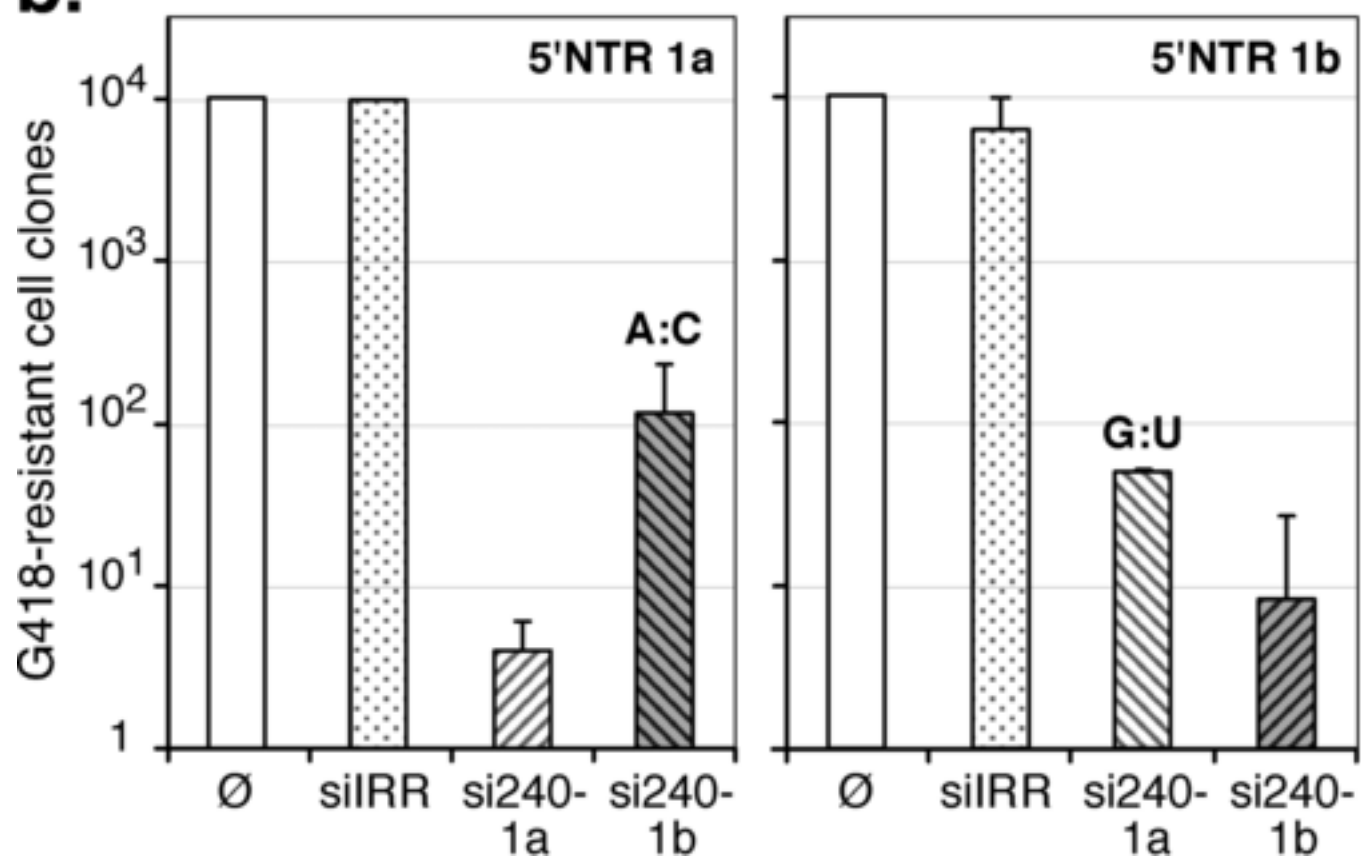

Figure 5
[Click here to download high resolution image](#)

